

Varenummer: 3901150056700  
 Beskrivelse: Snekkegear med fri indgangsaksel  
 VF 150P-56-HS

## Mål

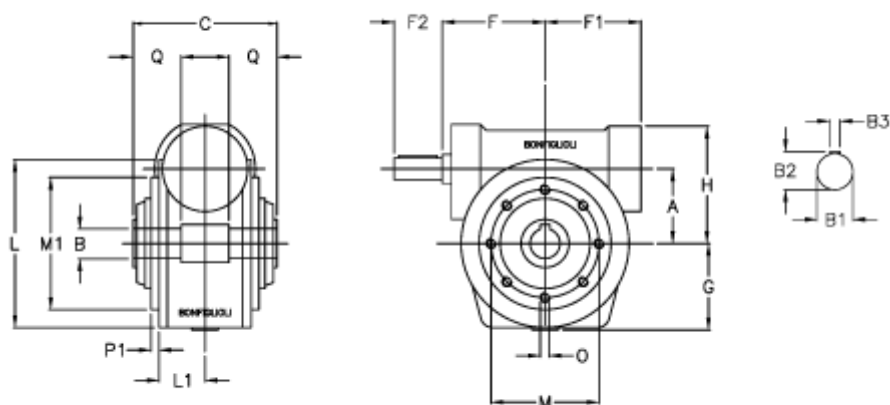

|            |                 |    |         |    |          |
|------------|-----------------|----|---------|----|----------|
| a          | = 150.0         | F1 | = 179   | O  | = M14x23 |
| B          | = 50            | F2 | = 65    | P1 | = 4.0    |
| B1         | = 35            | g  | = 180   | Q  | = 55.0   |
| B2         | = 38.0          | H  | = 218   |    |          |
| B3         | = 10            | L  | = 250.0 |    |          |
| Betegnelse | = VF 150P-xx-HS | L1 | = 83.5  |    |          |
| C          | = 175           | m  | = 215   |    |          |
| F          | = 185.0         | M1 | = 180   |    |          |